

Produktfamilie

SPOTY ROUND 5

Einbaustrahler aus Aluminium, in verschiedenen Gehäusefarben erhältlich, mit rückversetzerm LED-Einsatz, starr, mit verschiedenen LED Einsätzen bestückbar, auch mit neuer LED-Technik WARMDIM und TUNABLE WHITE, Standard mit 30° Linse (andere Version auf Anfrage), CRI>95Ra (ausgenommen Tuneable White Einsatz CRI90Ra), inkl. externem Konverter (dimmbar Phasen- bzw. Phasenabschnitt), optional DALI/SwitchDim



EIGENSCHAFTEN

- aus Aluminium
- starr
- 4 Gehäusefarben zur Auswahl
- mit rückversetzerm LED Einsatz
- 5 LED-Einsätze zur Auswahl
- für Deckenausschnitt Ø 77mm
- Schutzart: IP20
- inkl. externem Konverter (dimmbar Phasen- bzw. Phasenabschnitt) optional DALI/SwitchDim

VORTEILE

- mit neuer LED-Technik WARMDIM und TUNABLE WHITE



Produktübersicht

Gehäusefarbe:



schwarz



gold



alu gebürstet

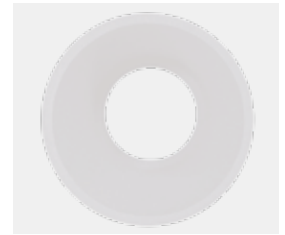

weiss

LED-Einsätze:



LED Einsatz 7W



LED Einsatz 13W



LED Einsatz 7W Warmdim



LED Einsatz 13W Warmdim



LED Einsatz Tunable White

Lichtfarbe:



2700K superwarmweiß

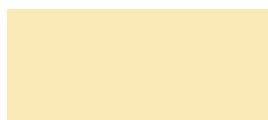

3000K warmweiß

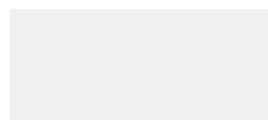

4000K neutralweiß



1800K - 3000K WarmDim



2700K - 6000K

Steuerung:



Phasen- bzw. Phasenabschnitt dimmbar



DALI dimmbar (auf Anfrage)

Skizzen:

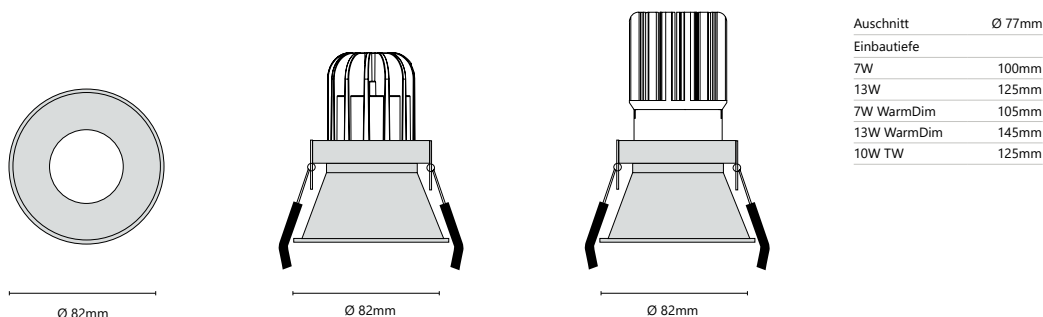

Technische Informationen:

7W EINSATZ

Watt Total:	7W		
Nettolumen:	492lm	492lm	614lm
Kelvin (CCT):	2700K	3000K	4000K
Schutzart:	IP20		
CRI:	>95Ra		
Winkel:	30°		
Lebenserwartung:	50.000h		
Spannung:	100 ~ 230V AC/ 700mA DC		

13W EINSATZ

Watt Total:	13W		
Nettolumen:	1010lm	1109lm	1333lm
Kelvin (CCT):	2700K	3000K	4000K
Schutzart:	IP20		
CRI:	>95Ra		
Winkel:	30°		
Lebenserwartung:	50.000h		
Spannung:	100 ~ 230V AC/ 350mA DC		

7W WARM DIM EINSATZ

Watt Total:	7W		
Nettolumen:	570lm		
Kelvin (CCT):	1800K - 3000K		
Schutzart:	IP20		
CRI:	>95Ra		
Winkel:	30°		
Lebenserwartung:	50.000h		
Spannung:	100 ~ 230V AC/ 350mA DC		

13W WARM DIM EINSATZ

Watt Total:	13W		
Nettolumen:	1150lm		
Kelvin (CCT):	1800K - 3000K		
Schutzart:	IP20		
CRI:	>95Ra		
Winkel:	30°		
Lebenserwartung:	50.000h		
Spannung:	100 ~ 230V AC/ 350mA DC		

10W EINSATZ

Watt Total:	10W		
Nettolumen:	900~930lm		
Kelvin (CCT):	2700K - 5700K		
Schutzart:	IP20		
CRI:	>90Ra		
Winkel:	30°		
Lebenserwartung:	50.000h		
Spannung:	100 ~ 230V AC/ 350mA DC		

Artikelübersicht:

Artikelnummer	① Watt	② Kelvin	③ Linse	④ Farbe	Steuerung
LW25-R5-①-②-③-④	» 07 « 7W	» 2700 « » 3000 « » 4000 «	» 1 « 30° (Standard)	» B « schwarz	dimmbar Phasenan-, Phasenabschnitt (Standard) DALI/SwitchDim (auf Anfrage)
	» 13 « 13W	» 2200 « (warmdim)		» G « gold	
	» 10 « 10W	» TW « (2700-5700K)		» S « alu gebürstet	
				» W « weiss	

1800K



3000K



2700K



5700K

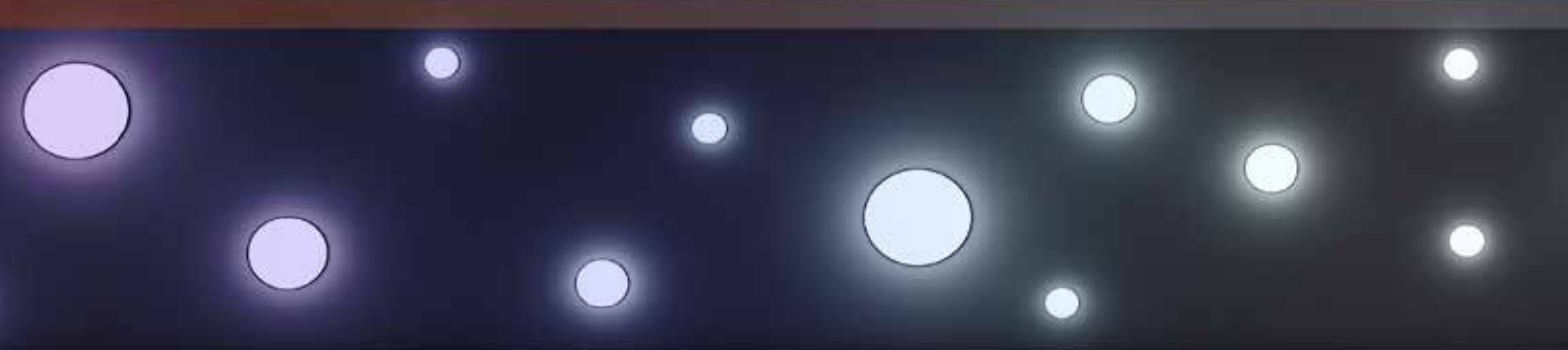

Sonderzubehör:



Blendschutz



Linse 15°



Linse 50°



opale Scheibe



Wabenraster



Schutzglas IP44

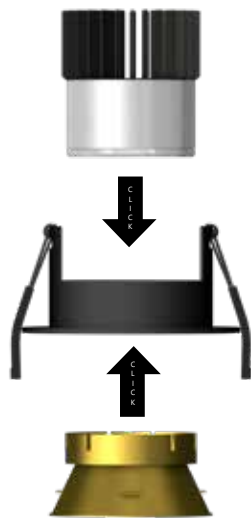

Standard Version

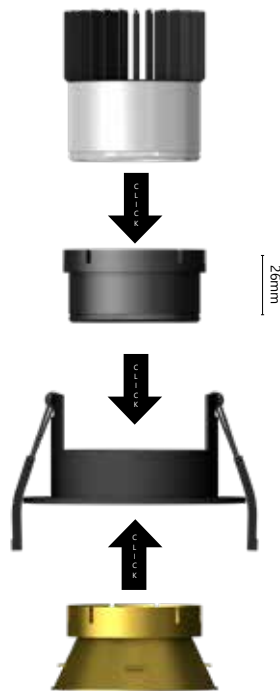

Version mit rückversetztem Blendschutzring

Anwendung mit Blendschutz

Mit dem neuen Blendschutzring für LED-Einsatz 7W oder 13W erreichen Sie eine rückversetzte und blendungsfreie Optik.

Achtung durch den Blendschutzring erhöht sich die Einbautiefe des Einbaustrahlers SPOTY um 26mm.