



LED PROFILE

LED PROFILE IM ÜBERBLICK



CLIP HIGH



CLIP LOW

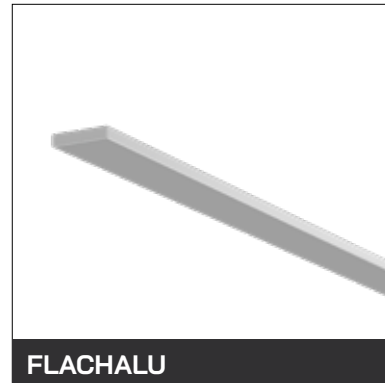

FLACHALU



MICRO 1



MICRO 2



MICRO 3A



MICRO 3 EB



MICRO 5 SMALL



MICRO 5 MEDIUM

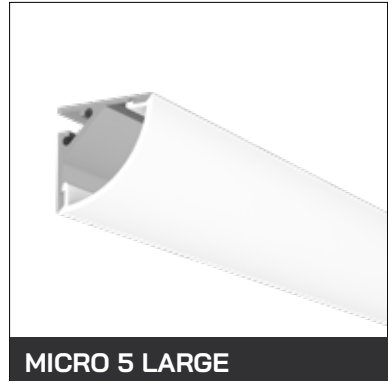

MICRO 5 LARGE



MICRO 13



PROFIL CLIP HIGH

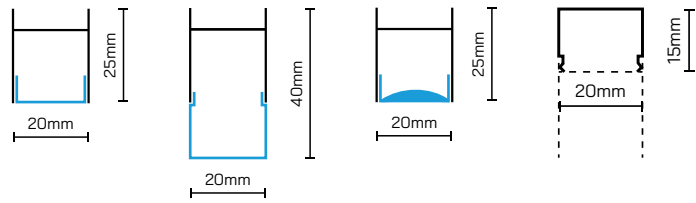

- Passend für LED-Bänder bis 20W/m in IP20 | IP68 und einer max. Breite von 16mm
- Ausführung mit Vergusstechnik IP67 | IP68 möglich
- Stangenlänge: 6100mm

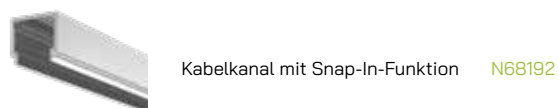
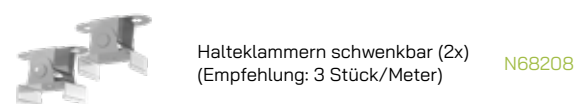
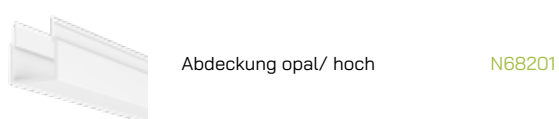
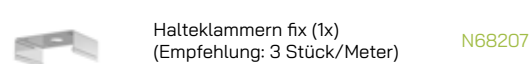
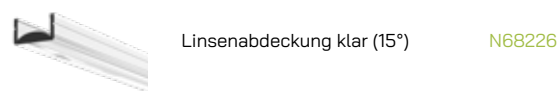
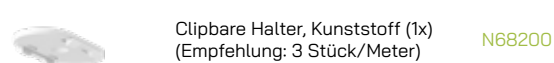
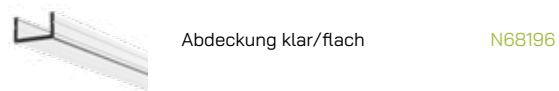
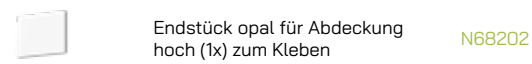
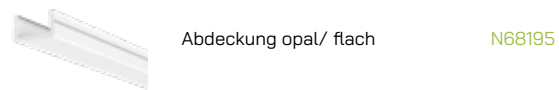
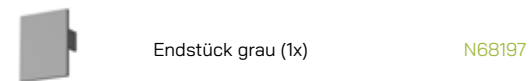
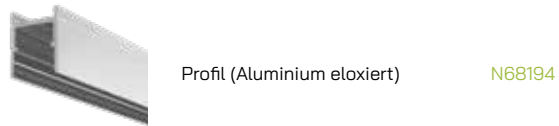
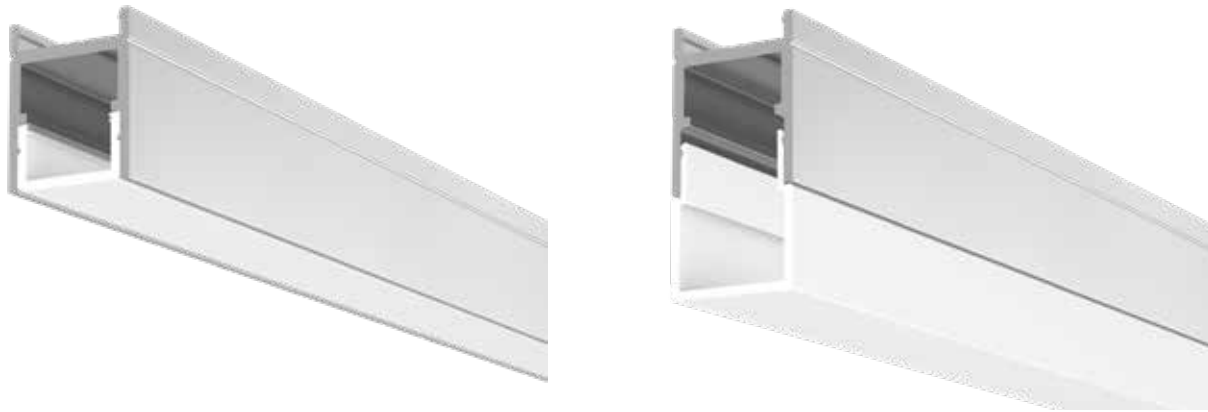

PROFIL CLIP LOW

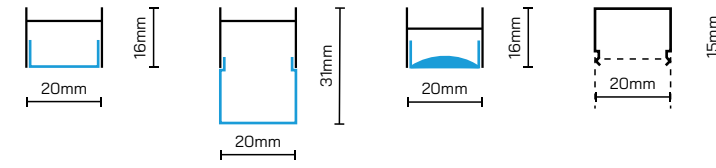

- Passend für LED-Bänder bis 20W/m in IP20 und einer max. Breite von 12mm
- Ausführung mit Vergusstechnik IP67 | IP68 möglich
- Stangenlänge: 6100mm

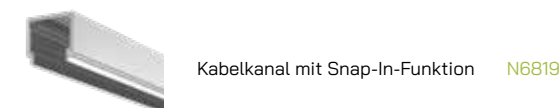
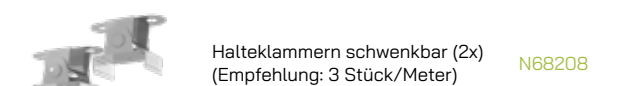
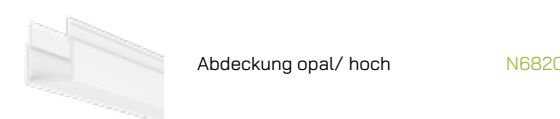
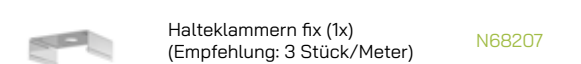
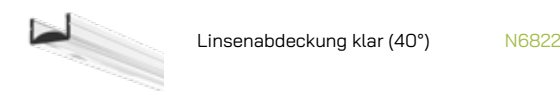
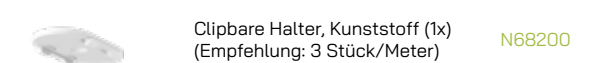
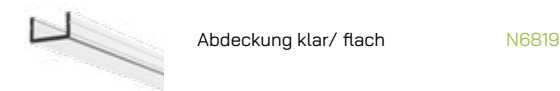
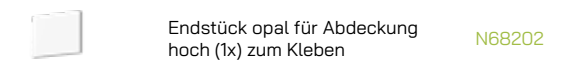
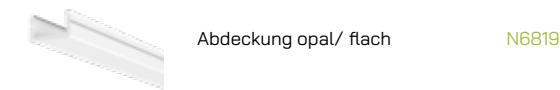
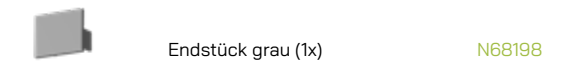
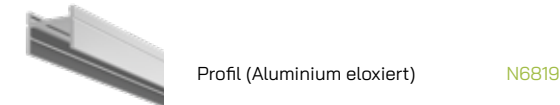
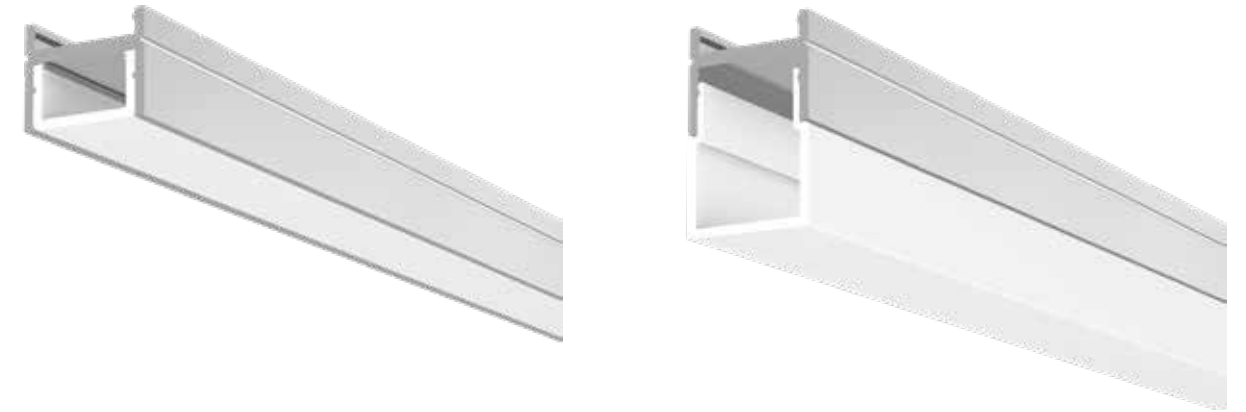

PROFIL MICRO 1

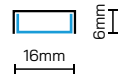

- Passend für LED-Bänder bis 10W/m in IP20 und einer max. Breite von 10mm
- Stangenlänge: 4100mm



Profil (Aluminium eloxiert)

N68203



Abdeckung klar/ flach

N68206



Abdeckung opal/ flach

N68205



Endstück (1x)

N68217

PROFIL MICRO 2

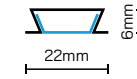

- Passend für LED-Bänder bis 10W/m in IP20 und einer max. Breite von 10mm
- Stangenlänge: 4100mm



Profil (Aluminium eloxiert)

PLB3775/1

Endstück grau mit
Kabelausgang (1x)

PL1448



Abdeckung opal/ flach

PL1547/1



Endstück grau (1x)

PL1430

PROFIL FLACHALU

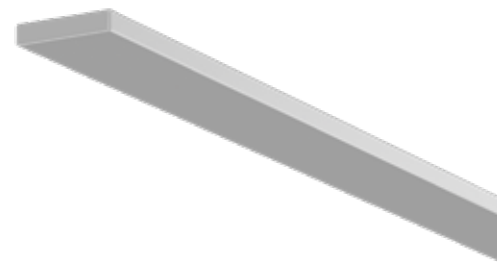

- Passend für LED-Bänder bis 10W/m in IP20 und einer max. Breite von 10mm
- Stangenlänge: 2000mm

Flachalu

N68240



PROFIL MICRO-3A

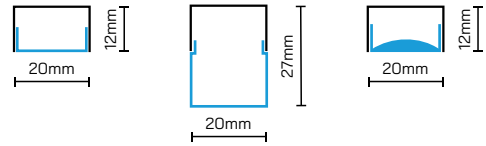

- Passend für LED-Bänder bis 20W/m in IP20 und einer max. Breite von 12mm
- Ausführung mit Vergusstechnik IP67 | IP68 möglich
- Stangenlänge: 6100mm

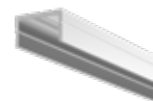
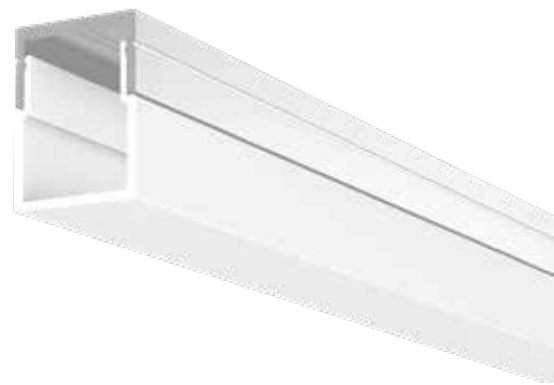

Profil (Aluminium eloxiert)

N68191



Endstück grau (1x)

N68199



Abdeckung opal/ flach

N68195



Endstück opal für Abdeckung hoch (1x) zum Kleben

N68202

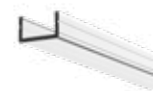

Abdeckung klar/ flach

N68196

Halteklammern fix (1x)
(Empfehlung: 3 Stück/Meter)

N68207



Linsenabdeckung klar (40°)

N68226

Halteklammern schwenkbar (2x)
(Empfehlung: 3 Stück/Meter)

N68208



Abdeckung opal/ hoch

N68201

PROFIL MICRO-3EB

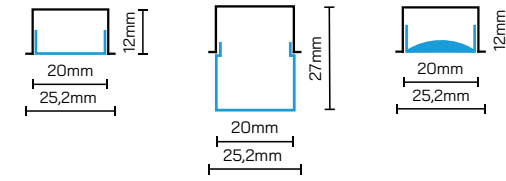

- Passend für LED-Bänder bis 20W/m in IP20 und einer max. Breite von 12mm
- Ausführung mit Vergusstechnik IP67 | IP68 möglich
- Stangenlänge: 6100mm



Profil (Aluminium eloxiert)

N68190



Abdeckung opal/ hoch

N68201



Abdeckung opal/ flach

N68195



Endstück grau (1x)

N68218

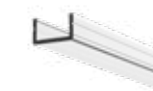

Abdeckung klar/ flach

N68196



Endstück opal für Abdeckung hoch (1x) zum Kleben

N68202



Linsenabdeckung klar (40°)

N68226

PROFIL MICRO-5 SMALL



- Passend für LED-Bänder bis 10W/m in IP20 und einer max. Breite von 10mm
- Stangenlänge: 4100mm



Profil (Aluminium eloxiert)

N68204



Abdeckung klar/flach

N68206



Abdeckung opal/ flach

N68205



Endstück (1x)

N68219

PROFIL MICRO-5 MEDIUM

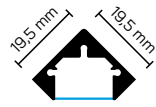

- Passend für LED-Bänder bis 20W/m in IP20 und einer max. Breite von 10mm
- Stangenlänge: 2000mm



Profil, Aluminium eloxiert

MEMCLEDD0140AR200



Abdeckung klar/flach

MEMCLEDD0100TR



Profil, Aluminium schwarz

MEMCLEDD0140VN200



Abdeckung schwarz/flach

MEMCLEDD0100PMFRN2



Endstück Set
Kunststoff
(1x geschlossen,
1x mit Schlitz)

alu
schwarz
weiss
MEMCLEDD0140ZK5PG
MEMCLEDD0140ZK5PN
MEMCLEDD0140ZK5PB



Endstück Set
Aluminium
(1x geschlossen,
1x mit Schlitz)

alu
schwarz
weiss
MCLEDD0140ZKIT5
MCLEDD0140ZKIT5N
MCLEDD0140ZKIT5B



Abdeckung opal/flach

MEMCLEDD0100PMFR32



Edelstahlklammern Set
für Montage

MEMCLEDDA040

PROFIL MICRO-5 LARGE

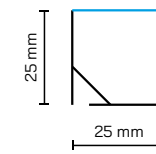
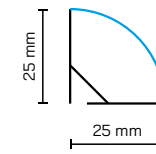

- Passend für LED-Bänder bis 20W/m in IP68 und einer max. Breite von 15mm
- Stangenlänge: 2000mm

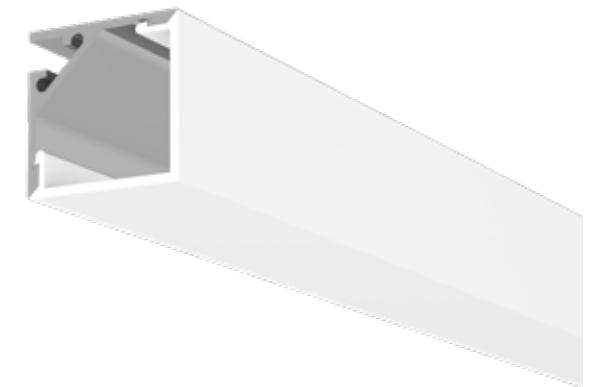
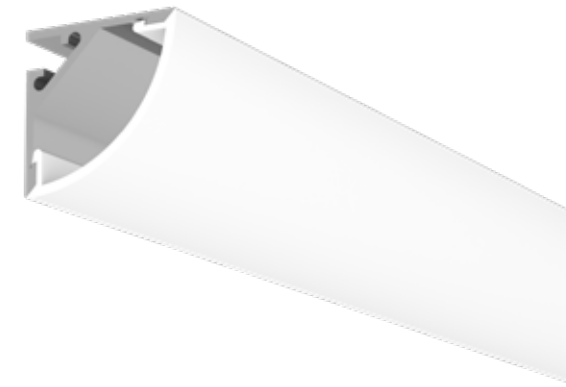

Profil MICRO-5 LARGE
(Aluminium)

AUT-AP-004-001



Abdeckung opal/ rund

AUT-AB-004-006



Abdeckung opal/ eckig

AUT-AB-004-003



Endkappe rund geschlossen (1x)

AUT-EK-004-110



Endkappe rund mit Langloch (1x)

AUT-EK-004-1112



Endkappe eckig geschlossen (1x)

AUT-EK-004-100



Endkappe eckig mit Langloch (1x)

AUT-EK-004-101

PROFIL MICRO-13

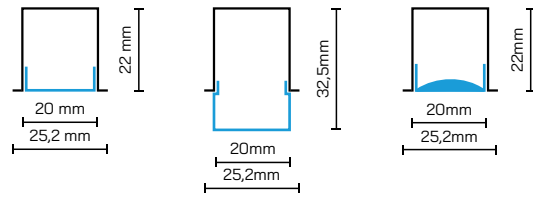

- Passend für LED-Bänder bis 20W/m in IP20 | IP68 und einer max. Breite von 16mm
- Ausführung mit Vergusstechnik IP67 | IP68 möglich
- Stangenlänge: 6100mm

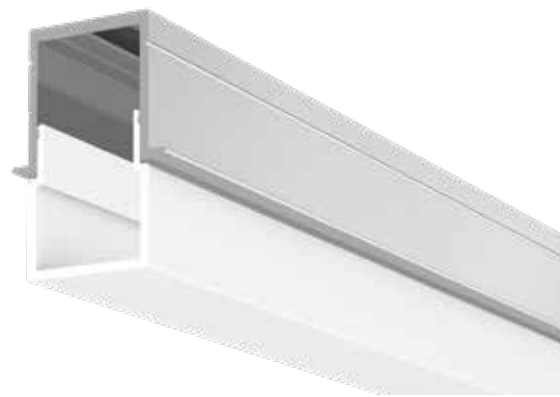

Profil (Aluminium eloxiert)

N68215

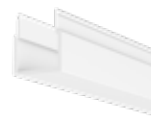

Abdeckung opal/ hoch

N68201



Abdeckung opal/ flach

N68195



Endstück grau (1x)

N68220

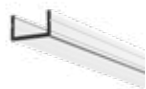

Abdeckung klar/ flach

N68196



Endstück opal für Abdeckung hoch (1x) zum Kleben

N68202



Linsenabdeckung klar (15°)

N68226

Einbaubügel (1x)
(Empfehlung: 3 Stück/Meter)

N68225

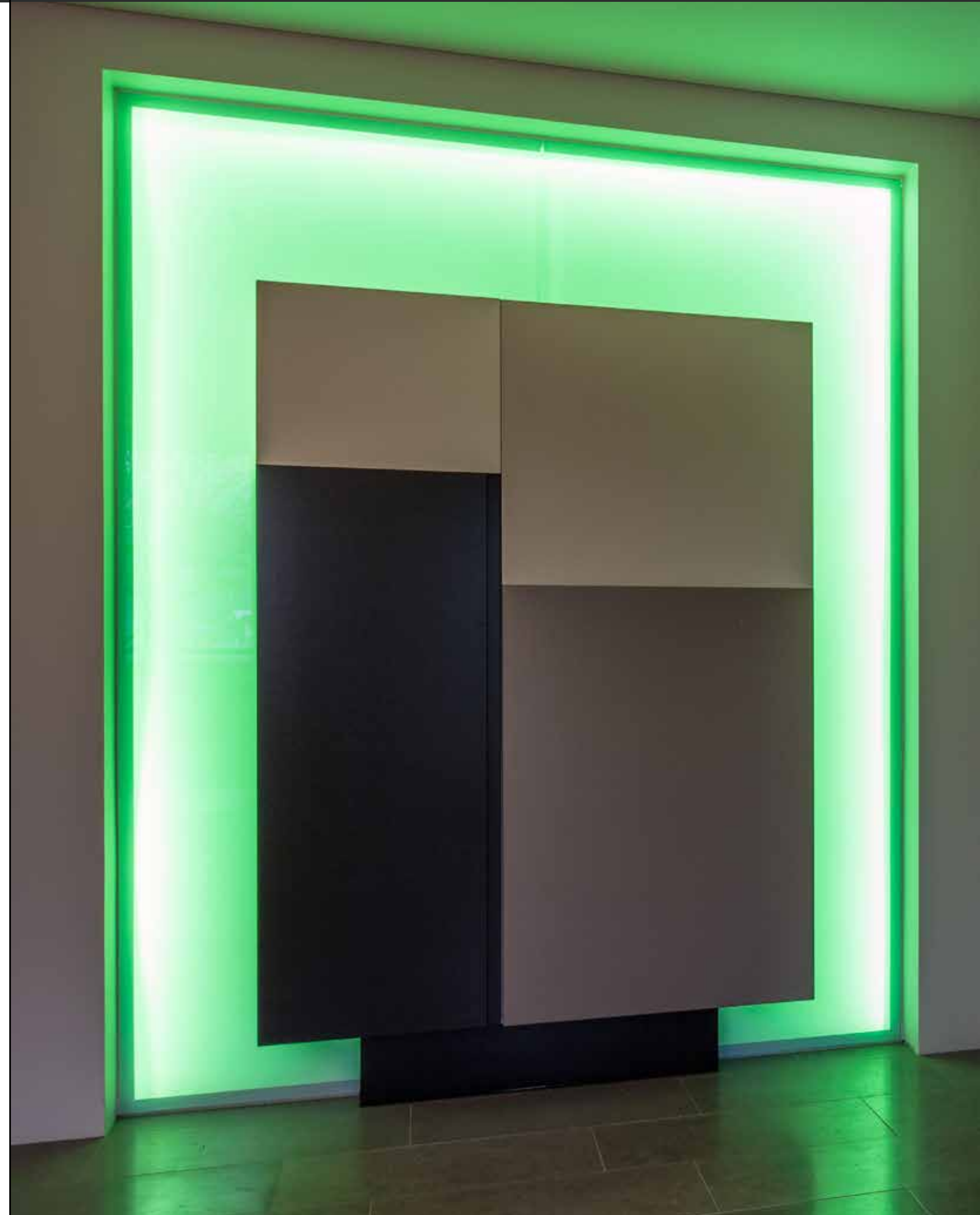

LEDWORKS®

manufacture & design

AUSTRIA/ GERMANY

LED-WORKS AUSTRIA GmbH
Au 54
A-6134 Vomp

Fon +43 (0)524266258
Mail info@led-works.eu
Web www.led-works.eu

Editor, Design, Idea, Concept: LED-WORKS AUSTRIA GmbH

Photographs: Ulrich Steinlechner, bild(ART)isten, Austria | Daniel Thalmann, Switzerland | Hannes Dabernig, Austria | Steve troes fotodesign

Allgemeine Verkaufs- und Lieferbedingungen finden Sie jeweils in unseren Preislisten. Alle Maßeinheiten wurden in Millimeter angegeben. Kopien und Auszüge aus dem Katalog oder Teile davon zu entnehmen, ist nur durch vorhergehende schriftliche Anfrage bzw. nachfolgendem und nachweisbarem Einverständnis des Herausgebers erlaubt. Der Herausgeber haftet nicht für eventuelle Druck- oder Satzfehler. Die in diesem Katalog angeführten Skizzen-, Größen-, Material- und Farbangaben sind rein indikativer Natur. Die Firma behält sich das Recht vor Charakteristika der Produkte jederzeit, ohne vorheriger Ankündigung zu ändern. Druckfehler und Irrtümer vorbehalten. Für alle Produkte gelten unsere AGB, sowie Liefer- und Zahlungsbedingungen.